





MODEL:FR84 - FOOT RAIL FOR 84" DRY BAR

Read this instruction carefully. Refer hardware and furniture parts list for guidance. Be sure all parts are complete, before assembling. Place all wooden furniture part on a clean and flat soft surface to prevent scratches. Refer steps provided as assembling guide

Part List		
ITEM	DESCRIPTION	QTY
1	Brackets 	2PCS
2	Brackets 	2PCS
3	Bar 	1PC

Hardware List		
ITEM	DESCRIPTION	QTY
A	Bolt (1/4" *1-3/4") 	10PCS
B	Washers (Dia 16mm) 	6PCS

Step 1 Drill 6pcs 3/8 inch(9-10mm)holes in premarked locations on bar.

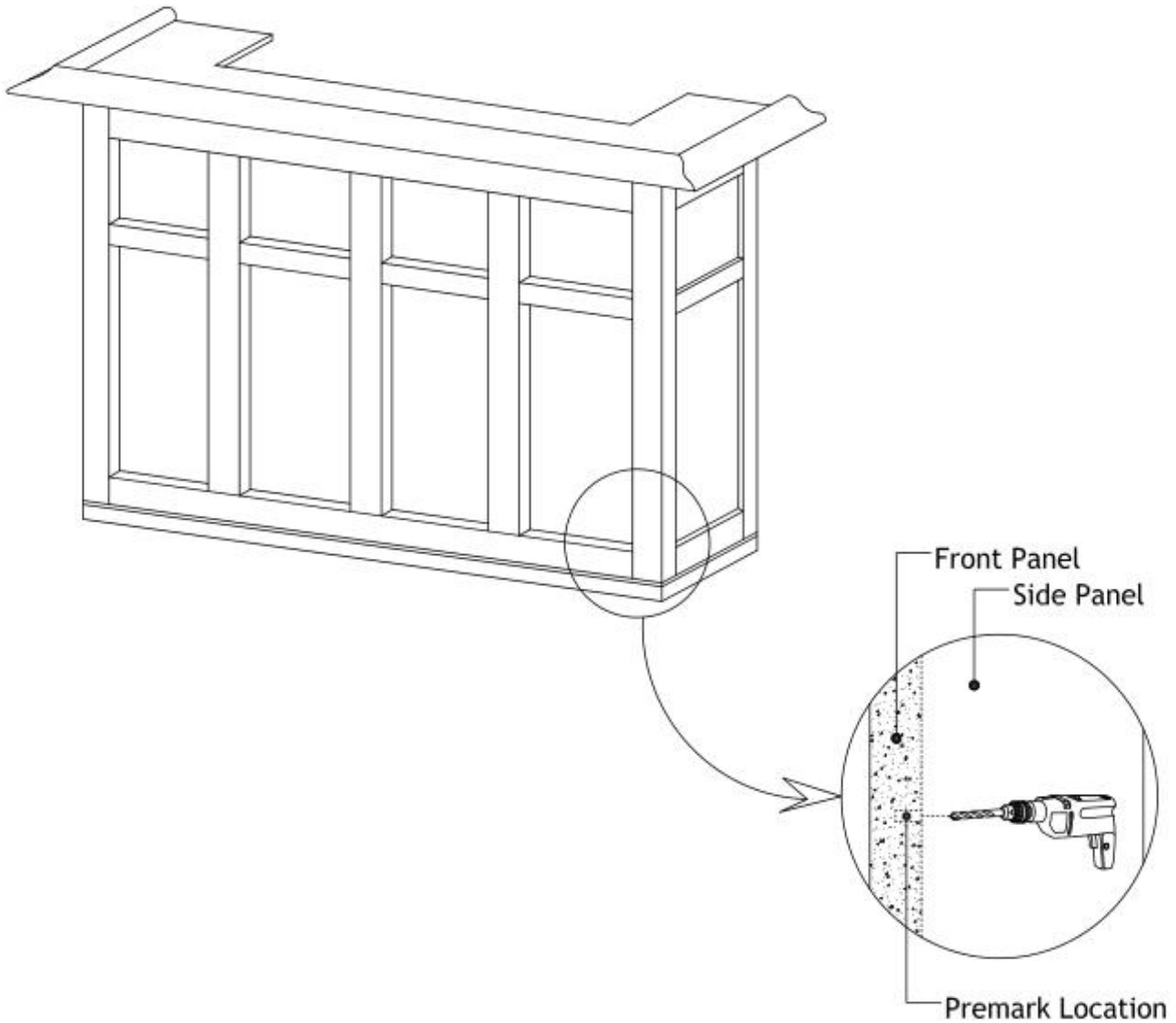

Step 2

Loosely fit all hardware to rail, bar and supports.

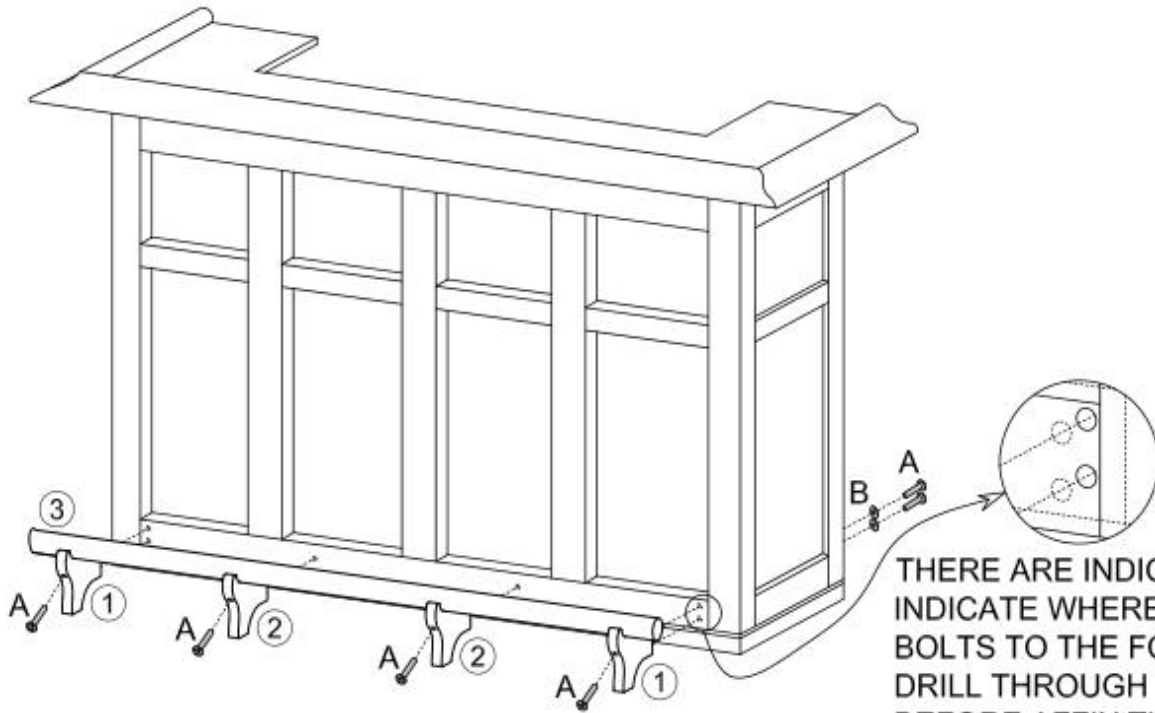

THERE ARE INDICATION MARKS INDICATE WHERE TO AFFIX THE BOLTS TO THE FOOT RAIL. PLEASE DRILL THROUGH THE MARKS BEFORE AFFIX THE BOLTS TO THE FOOT RAIL.

Step 3

Tighten bolts on foot rail 1st then tighten bolts inside bar to secure.

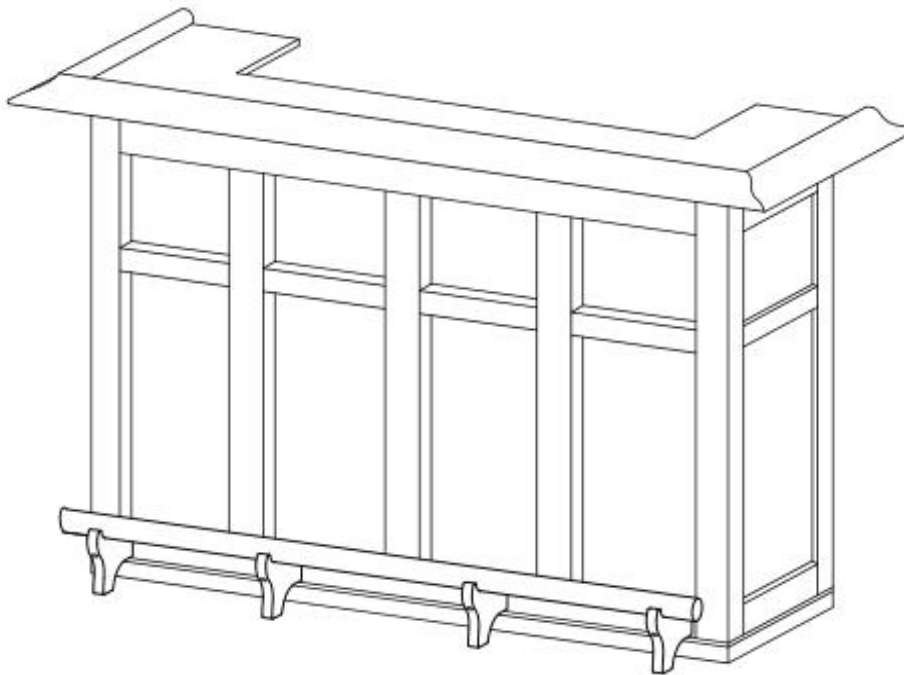

COMPLETED ASSEMBLY