

















MODEL:DBAR60-60"DRY BAR WITH OPTIONAL FRIDGE POCKET

PART LIST			
1	Top Panel		1PC
2	Front Panel		1PC
3	Right Side Panel		1PC
4	Left Side Panel		1PC
5	Middle panel		1PC
6	Tail Board		1PC
7	Middle Shelf		1PC
8	Left Shelf		1PC
9	Right Shelf		1PC
10	Bottom		1PC

HARDWARE LIST			
A	JCBC Screw (Ø1/4" * 40mm)		6PCS
B	Washers		6PCS
C	Wood Dowels		16PCS
D	CSK Screw (Ø8mm * 25mm)		60PCS
E	Shelf Pin		4PCS
F	Glue		1PC
G	Angle Iron		1PC
H	Screw (Ø3mm * 15mm)		2PC

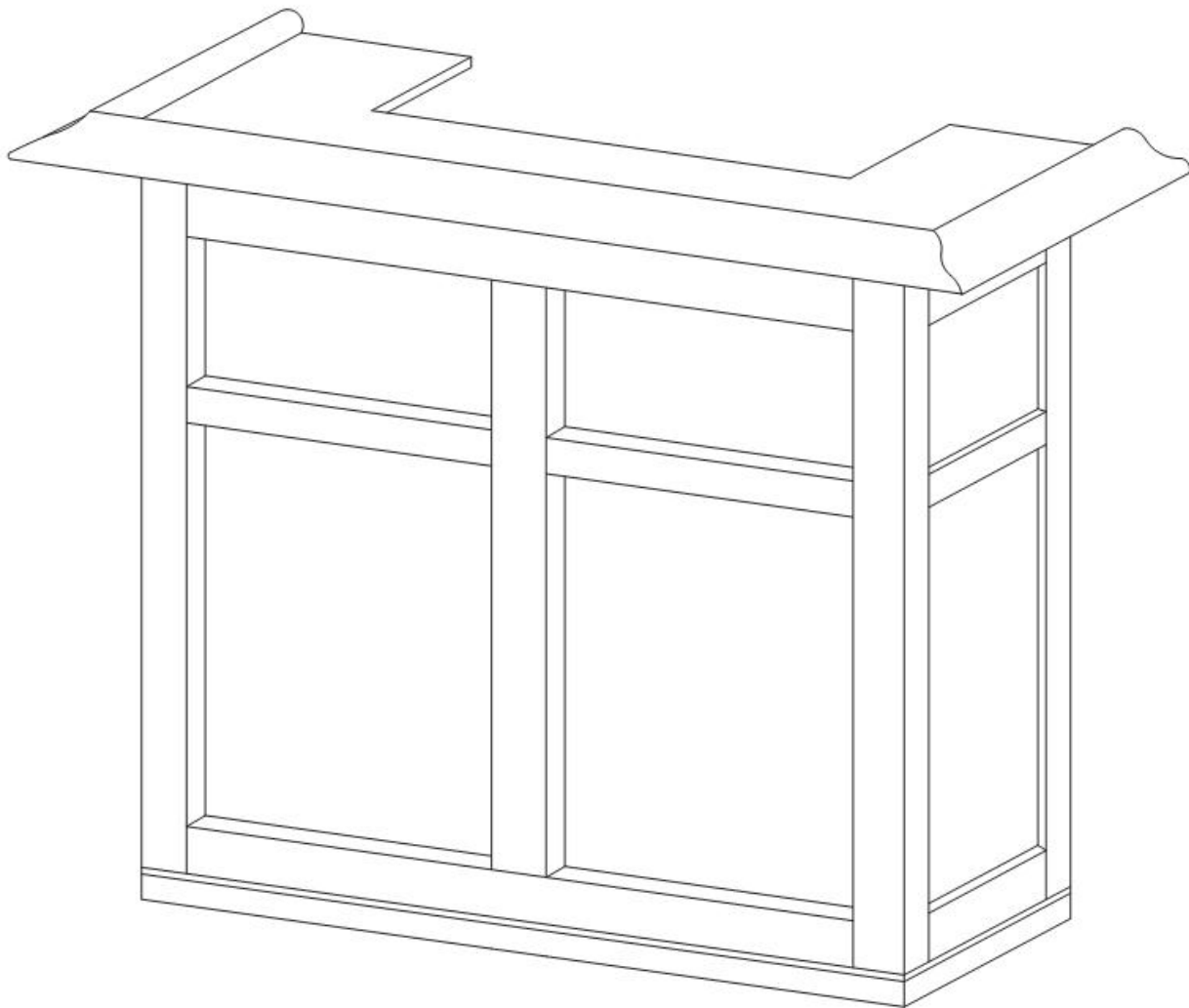

COMPLETED ASSEMBLY

Step 1

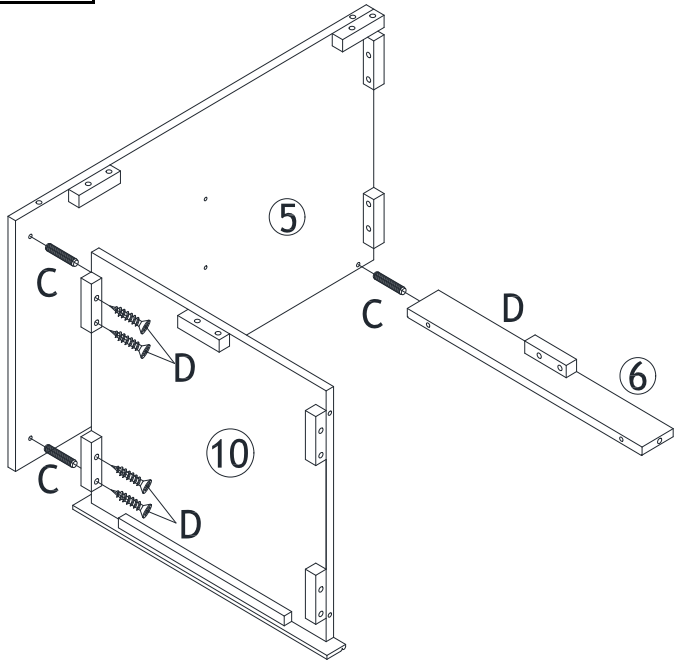

Step 2

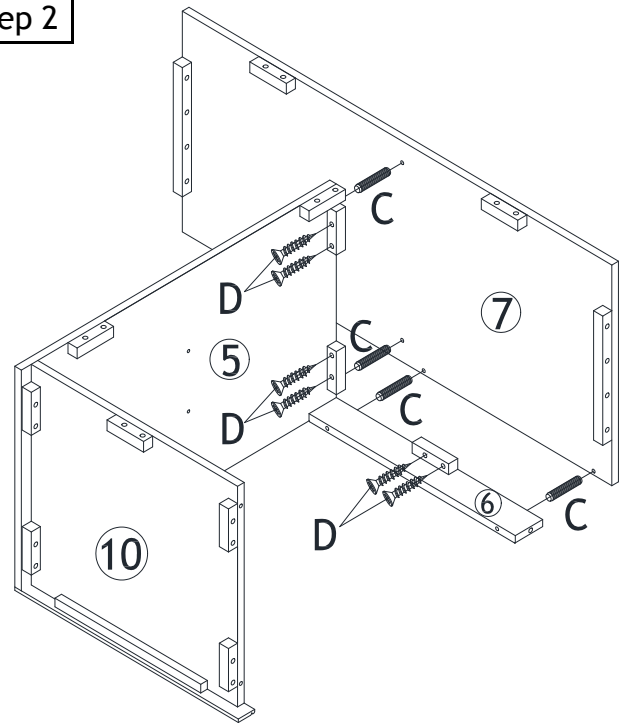

Step 3

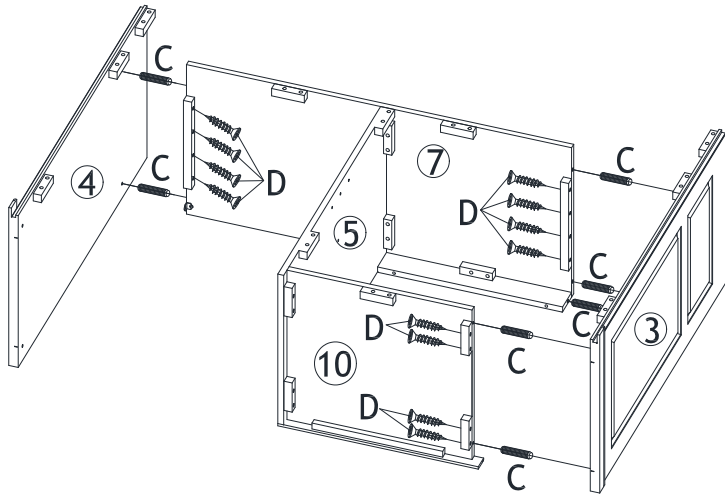

Step 4

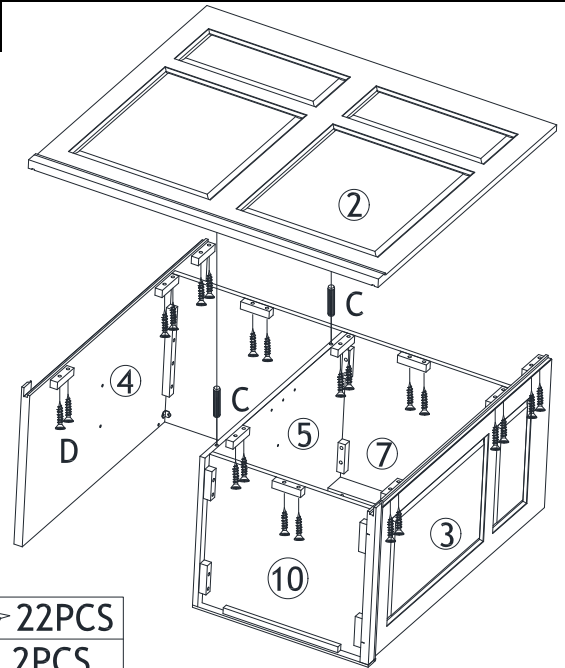

 22PCS
 2PCS

Step 5

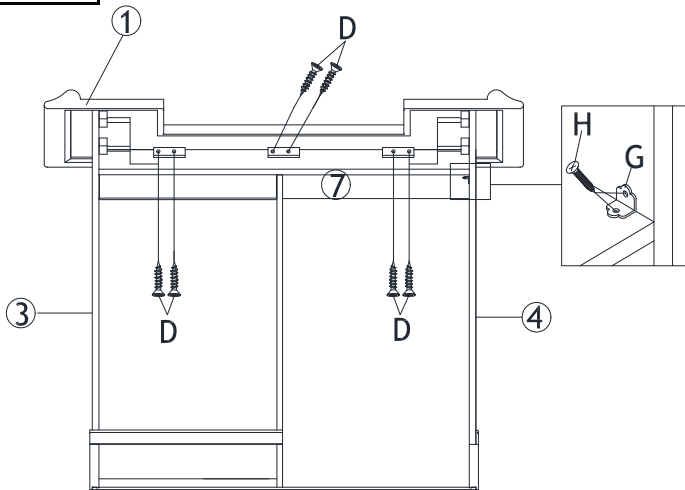

 14PCS

Step 6

